

Pressure Transmitter - ATEX / IECEx certified

PTM/Ex - Programmable Pressure Transmitter

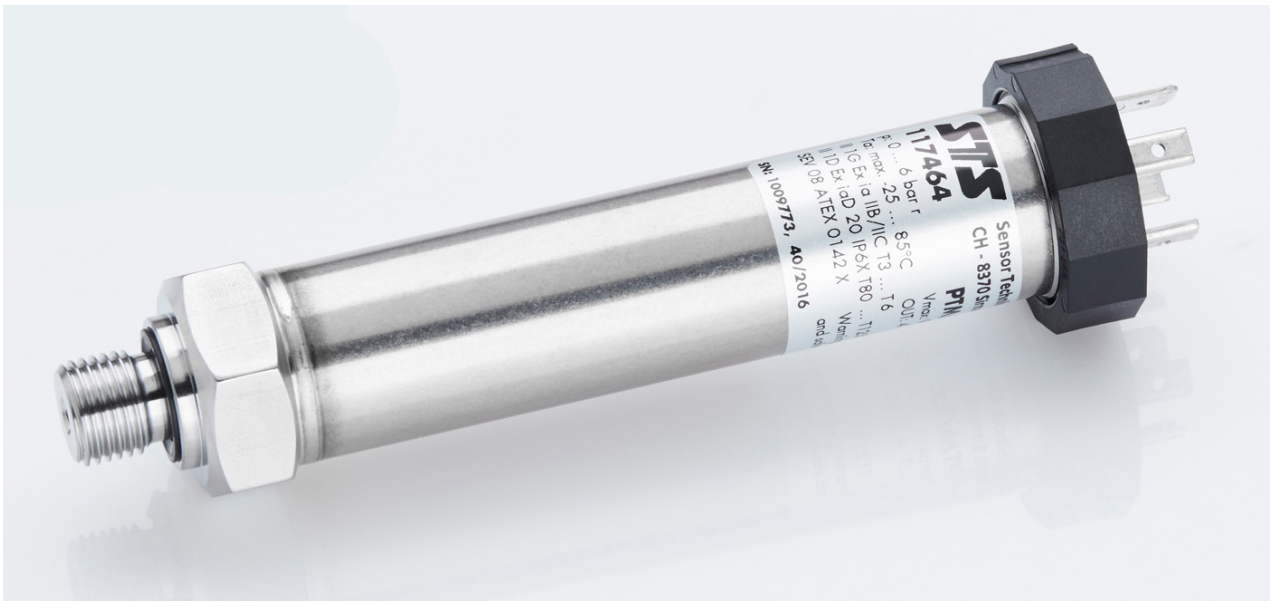

CUSTOMER BENEFITS

- Certificates: ATEX, IECEx, EAC, GOST, ABS, DNV, Lloyds
- Any measuring ranges between 0 ... 100 mbar and 0 ... 1000 bar available
- Static accuracies available to 0.1 %FS
- High flexibility due to scalable pressure range
- Hysteresis and repeatability better than 0.025 %
- Piezoresistive technology suitable for static and dynamic pressure measurements
- Adjustment of zero and span setting via PC software in the field
- Barometric pressure ranges available

Technical Specifications

PRESSURE MEASURING RANGE (BAR)

Pressure range	0 ... 0.1 to 0 ... 0.5	0 ... > 0.5 to 0 ... 2	0 ... > 2 to 0 ... 25
Overpressure (Proof)	3 bar	3 bar / 3 x FS	3 x FS
Burst pressure	> 200 bar	> 200 bar	> 200 bar
Accuracy, (3), \pm % FS	≤ 0.25	≤ 0.1	≤ 0.1
Thermal error, (4) (\pm % FS/ $^{\circ}$ C)			
Zero point: 0 ... 70 $^{\circ}$ C	≤ 0.06	≤ 0.03	≤ 0.015
Zero point: -25 ... 85 $^{\circ}$ C	≤ 0.08	≤ 0.04	≤ 0.02
Span: 0 ... 70 $^{\circ}$ C	≤ 0.015	≤ 0.015	≤ 0.015
Span: -25 ... 85 $^{\circ}$ C	≤ 0.02	≤ 0.02	≤ 0.02
Total Error, (5), (6), (7) (\pm % FS ; typ. / max.)			
-10 ... 50 $^{\circ}$ C	$\leq 0.15 / 0.3$ (≤ 200 mbar: 0.3 / 0.6)	$\leq 0.15 / 0.3$	$\leq 0.15 / 0.3$
-25 ... 85 $^{\circ}$ C	$\leq 0.65 / 0.7$ (≤ 200 mbar: 0.65 / 0.8)	$\leq 0.65 / 0.7$	$\leq 0.55 / 0.7$
Response time, (typ.)	16 ms	16 ms	16 ms
Long term stability (typ./max. per year)	< 1 mbar / < 2 mbar	< 1 mbar / < 2 mbar	< 0.1% FS / < 0.2% FS
Pressure range	0 ... > 25 to 0 ... 600, (2)	0 ... > 600 to 0 ... 1000	0.8 ... 1.2, (1)
Overpressure (Proof)	3 x FS ($\leq 850 / \leq 1500$ bar)	$\leq 850 / \leq 1500$ bar	3 x FS
Burst pressure	> 850 / > 1500 bar	> 850 / > 1500 bar	> 200 bar
Accuracy, (3), \pm % FS	≤ 0.1	≤ 0.25	≤ 0.25
Thermal error, (4) (\pm % FS/ $^{\circ}$ C)			
Zero point: 0 ... 70 $^{\circ}$ C	≤ 0.015	≤ 0.015	≤ 0.06
Zero point: -25 ... 85 $^{\circ}$ C	≤ 0.02	≤ 0.02	≤ 0.08
Span: 0 ... 70 $^{\circ}$ C	≤ 0.015	≤ 0.015	≤ 0.015
Span: -25 ... 85 $^{\circ}$ C	≤ 0.02	≤ 0.02	≤ 0.02
Total Error, (5), (6), (7) (\pm % FS ; typ. / max.)			
-10 ... 50 $^{\circ}$ C	$\leq 0.15 / 0.3$	n.a.	$\leq 0.15 / 0.3$
-25 ... 85 $^{\circ}$ C	$\leq 0.55 / 0.7$	n.a.	$\leq 0.65 / 0.7$
Response time, (typ.)	16 ms	16 ms	16 ms
Long term stability (typ./max. per year)	< 0.1% FS / < 0.2% FS	< 0.1% FS / < 0.2% FS	< 1 mbar / < 2 mbar

(1) Typical barometric pressure range, max. offset: 900 mbar, min. span: 400 mbar

(2) Overpressure (proof) and burst pressure 1500 bar (stainless steel) optional

(3) Zero based accuracy according to EN-61298, incl. hysteresis and repeatability at ambient temperature

(4) Standard compensation

(5) Total error including accuracy and temperature influences at maximum signal span (16 mA)

(6) With option „Active compensation“ only (≥ 100 mbar, ≤ 100 bar)

(7) Does not apply to titanium solution ≤ 1 bar

TEMPERATURE RANGE

Operating temperature	-25 ... 85°C
Process temperature	
Standard:	-25 ... 100°C
Optional (with cooling fins):	-25 ... 150°C
Storage temperature	-25 ... 85°C

ELECTRICAL SPECIFICATIONS

Output signal	4 ... 20 mA
Resolution	0.025 %FS
Output adjustable	
4 mA	-5 %FS ... 105 %FS
20 mA	-5 %FS ... 105 %FS
Span	25 %FS ... 110 %FS
Low pass filter	0.1 / 1 / 10 / 30 Hz (standard: 30 Hz)
Power supply	9 ... 30 VDC
Supply influence	< 0.1 %FS

Circuit diagram

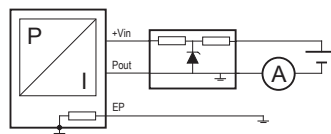

Load resistance

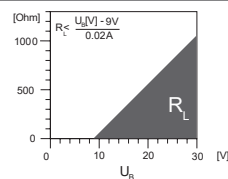

Load influence	< 0.1 %FS
Reverse polarity protection	Yes

CERTIFICATES / APPROVALS

Certificates, (1)

ATEX	SEV 08 ATEX 0142		
IECEX	IECEX SEV 19.0024X		
ABS	09-HG436727/1-PDA		
DNV	TAA00002FN		
Gas, (2)	Zone 0	II 1G Ex ia IIC T3 ... T6 Ga	
Gas, (3)	Zone 1+2	II 2G Ex ia IIB T3 ... T6 Gb	
Dust		II 1D Ex ia IIIC T ₂₀₀ 125°C Da	
Maximum values of the intrinsically safe circuit	30 V / 140 mA / 0.9 W		
Temperature class, (4)	T6	T4	T3
Ambient temperature (Ta)	-25 ... 55 °C	-25 ... 85 °C	-25 ... 85 °C
Process temperature	-25 ... 55 °C	-25 ... 100 °C	-25 ... 150 °C

(1) For detailed Ex specifications see certificate and operating and safety instructions

(2) Max. permitted cable length: ≤ 150 m

(3) Max. permitted cable length: ≤ 450 m

(4) Without any information about temperature class the transmitter will be delivered for T4

QUALIFICATIONS

	Description	Level
EN 60068-2-6	Vibration	4G (4 ... 100 Hz)
EN 60068-2-27	Shock	100 G (impulse duration 6 ms)
EN 61326-2-3	EMC	
EN 61000-6-2	EMC	
EN 61000-6-3	EMC	

PHYSICAL SPECIFICATIONS

Oil filling	Standard: Silicone Oil Optional: AS100 / Anderol Food / PAO 4
Transducer	Standard: Stainless steel (316L / 1.4435) Optional: Titanium (Gr. 2) or Hastelloy C-276
Housing	Standard: Stainless steel (316L / 1.4435) Optional: Titanium (Gr. 2) or Hastelloy C-276
Weight	typ. 200 gram, depending on the configuration

Accessories

CABLE SOCKET CONNECTOR

Article number	Description
HART001	Cable socket connector DIN43650 (EN 175301-803A)
HART002	Cable socket connector Binder 723, 5 pins
HART012	Cable socket connector MIL C26482, 10-6
HART018	Cable socket connector M12x1, 5 pins

INTERFACE / SOFTWARE

Article number	Description
102442	PTM/Ex - Interface
101224	PC Software

MANUALS

Article number	Description	
DEB003	Configuration software	10.00.0079
DEB005	User manual sensor	10.00.0089
DMM023	Operating and safety instructions	10.88.0271

Ordering information

Type	x	xxxx	xxxx	xx	xxx
PTM/Ex	47				
Pressure type					
Gauge	1				
Absolute	2				
Sealed gauge	3				
Pressure measuring range					
Any measuring ranges between 0 ... 100 mbar and 0 ... 1000 bar available		xx			
Barometric pressure ranges available		xx			
Process connection					
G 1/2 M, bore 14 mm (Fig. 1)		17			
G 1/4 F (Fig. 2)		00			
G 1/4 M (Fig. 3)		11			
G 1/4 M, manometer EN 837 (Fig. 4)		12			
G 1/2 M (Fig. 5)		13			
G 1/2 M, manometer EN 837 (Fig. 6)		16			
1/4 NPT M (Fig. 7)		10			
1/2 NPT M (Fig. 8)		19			
G 1/2 M, frontal diaphragm (Fig. 9), (1)		14			
G 1/2 M, frontal diaphragm Hastelloy C-276 (Fig. 9), (1)		37			
G 1/2 M, with flush diaphragm membrane (Fig. 10), (1)		15			
G 1/4, with flush diaphragm (Fig. 11), (1)		21			
Other pressure connections on request		99			
Electrical connection					
DIN 43650 (EN 175301-803A), demountable, IP 65, (Fig. 12), (2), (3)			01		
Binder 723, 5 pins, IP 67 (Fig. 13), (2)			03		
MIL C26482, 10-6, 316L, IP 67 (Fig. 14), (2)			80		
M12x1, 4 pins, (Fig. 15), (2)			07		
PUR cable, blue, IP 67, (Fig. 16), (4), (6)			17		
FEP cable, blue, IP 67, (Fig. 16), (4)			22		
PUR cable, blue, IP 68, (Fig. 17), (4), (6)			36		
Other electrical connections on request			99		
Output signal					
4 ... 20 mA			05		
4 ... 20 mA with overvoltage protection			08		
Accuracy					
$\leq \pm 0.25$ % FS (< 500 mbar / > 600 bar)				1	
$\leq \pm 0.1\%$ FS (≥ 500 mbar ... 600 bar)				2	

Temperature range	
T6 (Ta: -25 ... 55 °C) 0 ... 70 °C compensated (without cooling fins)	0
T4 (Ta: -25 ... 85 °C) -25 ... 85 °C compensated (without cooling fins)	1
T3 (Ta: -25 ... 85 °C) -25 ... 85 °C compensated (with cooling fins)	2
Options	
Throttle, (7)	A
Special oil filling: Anderol Food (for food applications)	G
Special oil filling: PAO4 (silicone free)	Q
Pressure connection elastomerfree	N
Pressure connection welded	V
Active compensated (≥ 100 mbar ≤ 100 bar)	E
Titanium, (9)	K
Seals: FKM (standard)	U
Seals: EPDM	S
Seals: Kalrez, (5)	T
Seals: NBR, (8)	H

(1) Process connection available ≤ 600 bar

(2) Cable socket connector not included

(3) IP67 if the cable socket connector HART001 is installed correctly

(4) Please specify the required cable length and medium

(5) Profile seal not included

(6) For operating temperature $> 50^{\circ}\text{C}$, PE or FEP cable must be used

(7) Only with pressure connection Fig. 3, Fig. 5, Fig. 6, Fig. 7 and Fig. 8

(8) Suitable for drinking water

(9) Titanium available for $P_n \leq 400$ bar (burst pressure max. 550 bar), not all versions are available in titanium

Process connections

$P_N \geq 100$ mbar ... 25 bar (1)

Fig. 1 - G 1/2 M, bore 14 mm

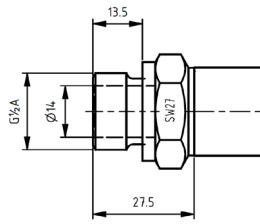

Fig. 5 - G 1/2 M

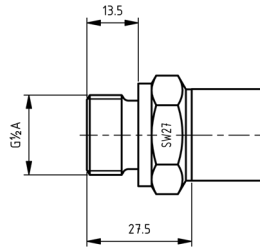

Fig. 2 - G 1/4 F

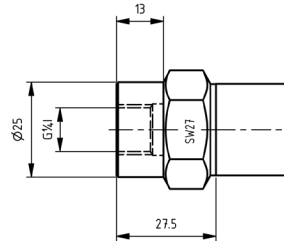

Fig. 6 - G 1/2 M, Manometer EN837

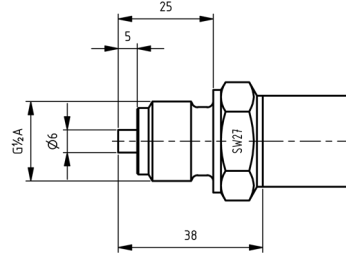

Fig. 3 - G 1/4 M

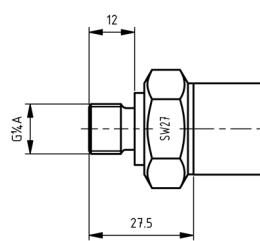

Fig. 7 - 1/4 NPT M

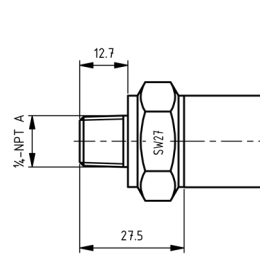

Fig. 4 - G 1/4 M, Manometer EN837

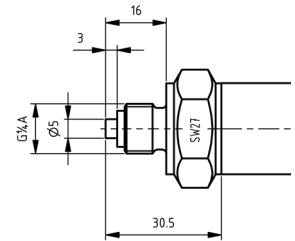
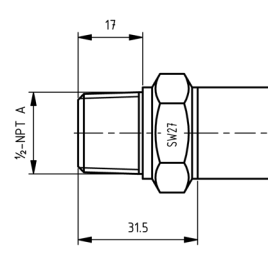

Fig. 8 - 1/2 NPT M



$P_N > 25$ bar ... 1000 bar (1) (2)

Fig. 2 - G 1/4 F

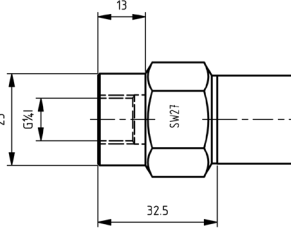

Fig. 3 - G 1/4 M

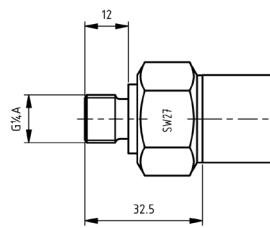

Fig. 4 - G 1/4 M, Manometer EN837

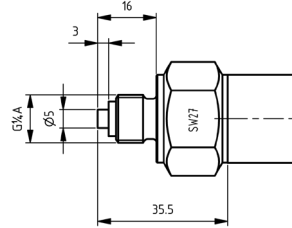

Fig. 5 - G 1/2 M

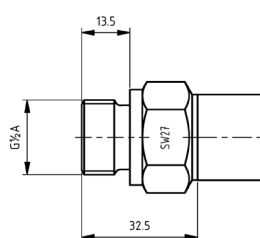

Fig. 6 - G 1/2 M, Manometer EN837

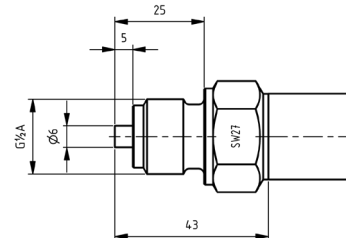

Fig. 7 - 1/4 NPT M

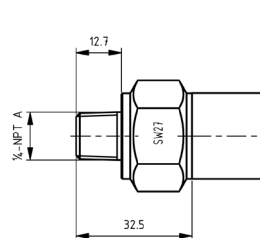
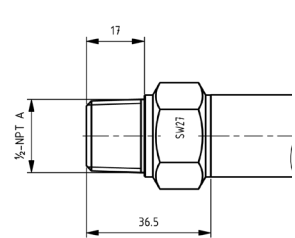
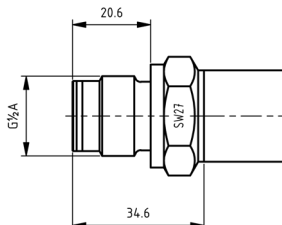

Fig. 8 - 1/2 NPT M



$P_N \geq 100$ mbar ... 600 bar

Fig. 9 - G 1/2 M, frontal diaphragm



$P_N \geq 100$ mbar ... 1000 bar (3)

Fig. 10 - G 1/2 M, flush diaphragm

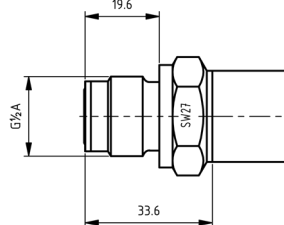

$P_N \geq 10$ bar ... 600 bar

Fig. 11 - G 1/4 M, flush diaphragm

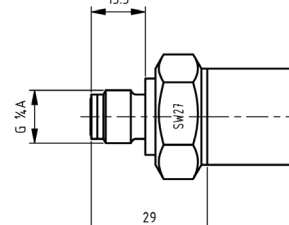

(1) Dimensions for welded or elastomerfree versions may be different
 (2) Not all process connections available for pressure ranges > 600 bar
 (3) Dimensions for pressure ranges > 600 bar differ

Dimensions

Version for medium temperature up to 100°C

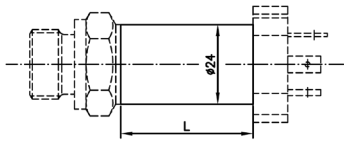

L = 94 mm for connector DIN 43650 (EN 175301-803A)

Version for medium temperature >100°C up to max. 150°C

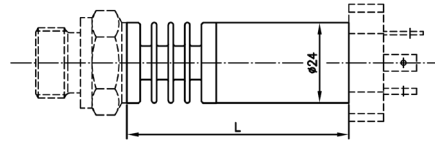

L = 121 mm for connector DIN 43650 (EN 175301-803A)

Electrical connections

Fig. 12 - DIN43650 (EN 175301-803A)

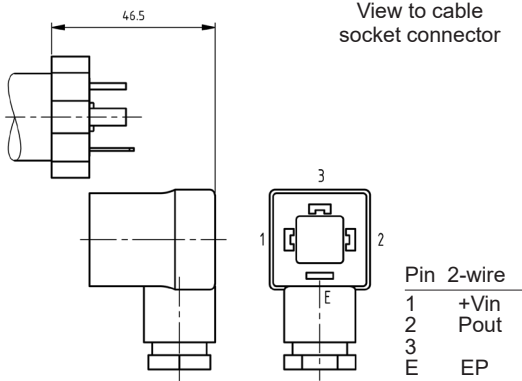

Fig. 13 - Binder 723, 5 pins

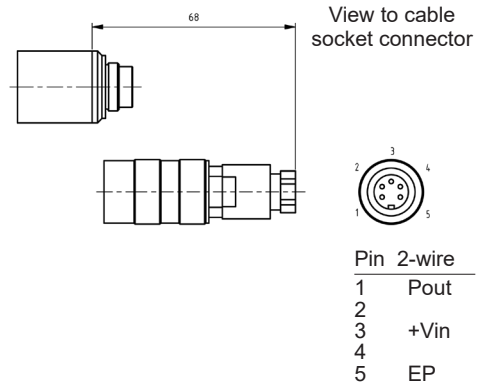

Fig. 14 - MIL C26482, 10-6, 316L

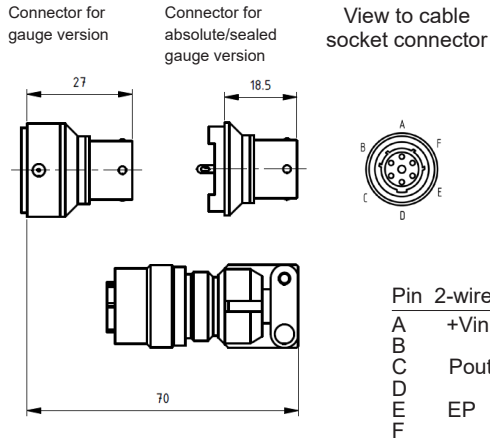

Fig. 15 - M12 x 1, 4 pins (Lumberg RSF4)

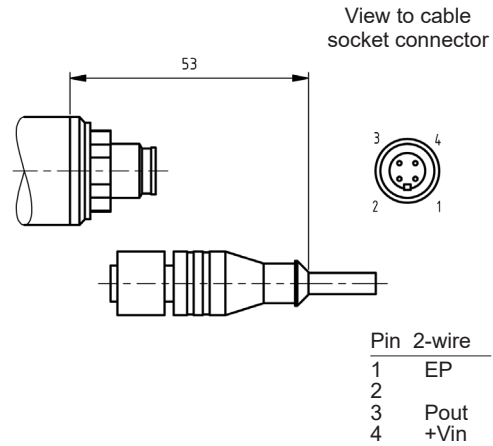

Fig. 16 - Cable connection IP67

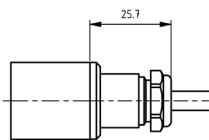
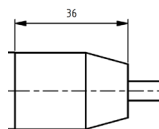

Fig. 17 - Cable connection IP68



Colour 2-wire	
white	+Vin
yellow	Pout
grey	EP

Specifications may change without notice

© 2022 - STS Sensor Technik Sirmach AG, Rütihofstrasse 8, CH - 8370 Sirmach, Switzerland, www.stssensors.com